

Fuoco Series Pizza Oven With Double Chamber And Digital Display

ITEM: 40643
MODEL: PE-IT-0049-DD



Efficient, and reliable

The Fuoco is an electric oven that was designed and built to offer extremely high levels of performance, efficiency and reliability with low operating costs. The digital version has an electronic card that is used to program the start to end of baking and two work settings (continuous/P2 and non-continuous/P1). The digital Fuoco has a safety thermostat and independent chambers. Upon request, some models can be produced with single-phase voltage.

FEATURES:

- Stainless steel front
- Pre-painted white grey body
- Steel door with glass
- Knob for opening and closing steam exhauster
- Non-thermal handles

* Special Order are available for the following upon request: stands, casters, hoods, vents and suction motor

1-833-487-3686

www.trentoequipment.com

sales@trentoequipment.com

Follow us on social media
[@trentoequipment](#)

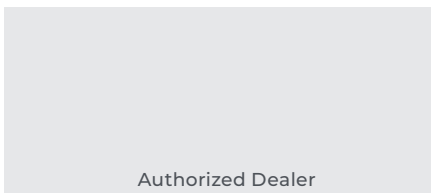

*Power cord and plug not included; must be installed by a certified electrician



Technical Drawings

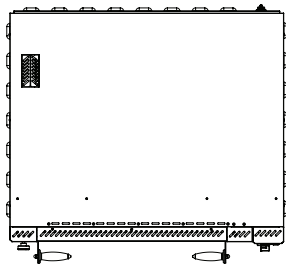
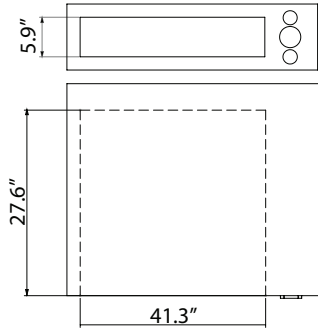
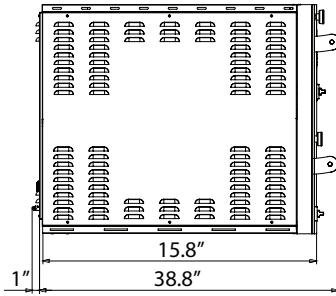
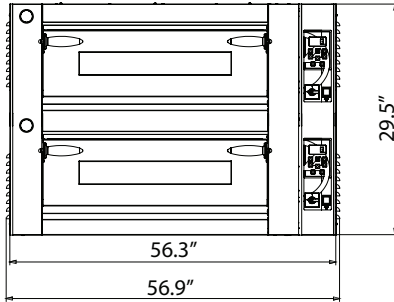

Technical Specification

Item	40643
Model	PE-IT-0049-DD
Maximum Temperature	842° F (450° C)
Power	18000 W
Electrical	220V / 60Hz / 3Ph
Chamber Dimensions (WDH)	41.3" x 27.6" x 5.9" (x2) (1050 x 700 x 150 mm) (x2)
Net Weight	508.2 lb. (231 kg.)
Net Dimensions (WDH)	56.7" x 39.8" x 29.5" (1440 x 1010 x 750 mm)
Gross Weight	558.8 lb. (254 kg.)
Gross Dimensions (WDH)	44" x 57.7" x 33" (1120 x 1470 x 840 mm)
Plug Type	Bare Wire

The Activestone

Therographic test shows that in a chamber heated by Activestone, the desired temperature can be reached within a shorter time span and heat is distributed evenly.

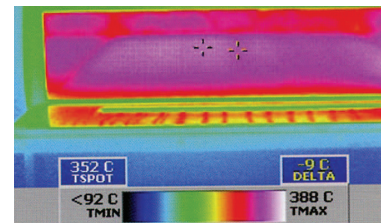
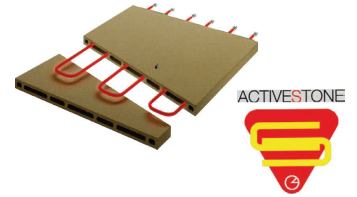

max 6 x 12"	max 6 x 13"	max 2 x 18"	max 2 x (24" x 16")

Related Accessories - (Sold Separately)

Item	Description	Net Dimensions (WDH)	Net Weight
40642	Stainless Steel Stand	Height with wheels: 56" x 35" x 33.4" (1422 x 889 x 848 mm)	95.2 lb. (42 kg.)
		Min. – Max. Height with Adjustable Feet: 31.7" – 34.2" (805 x 868 mm)	
40644	Stainless Steel Hood	56" x 45.47" x 11.9" (1422 x 1154 x 302 mm)	68.34 lb. (31 kg.)
40645	Wheels for All Pizza Oven Stands	Height: 6" (152 mm)	-